



1/2

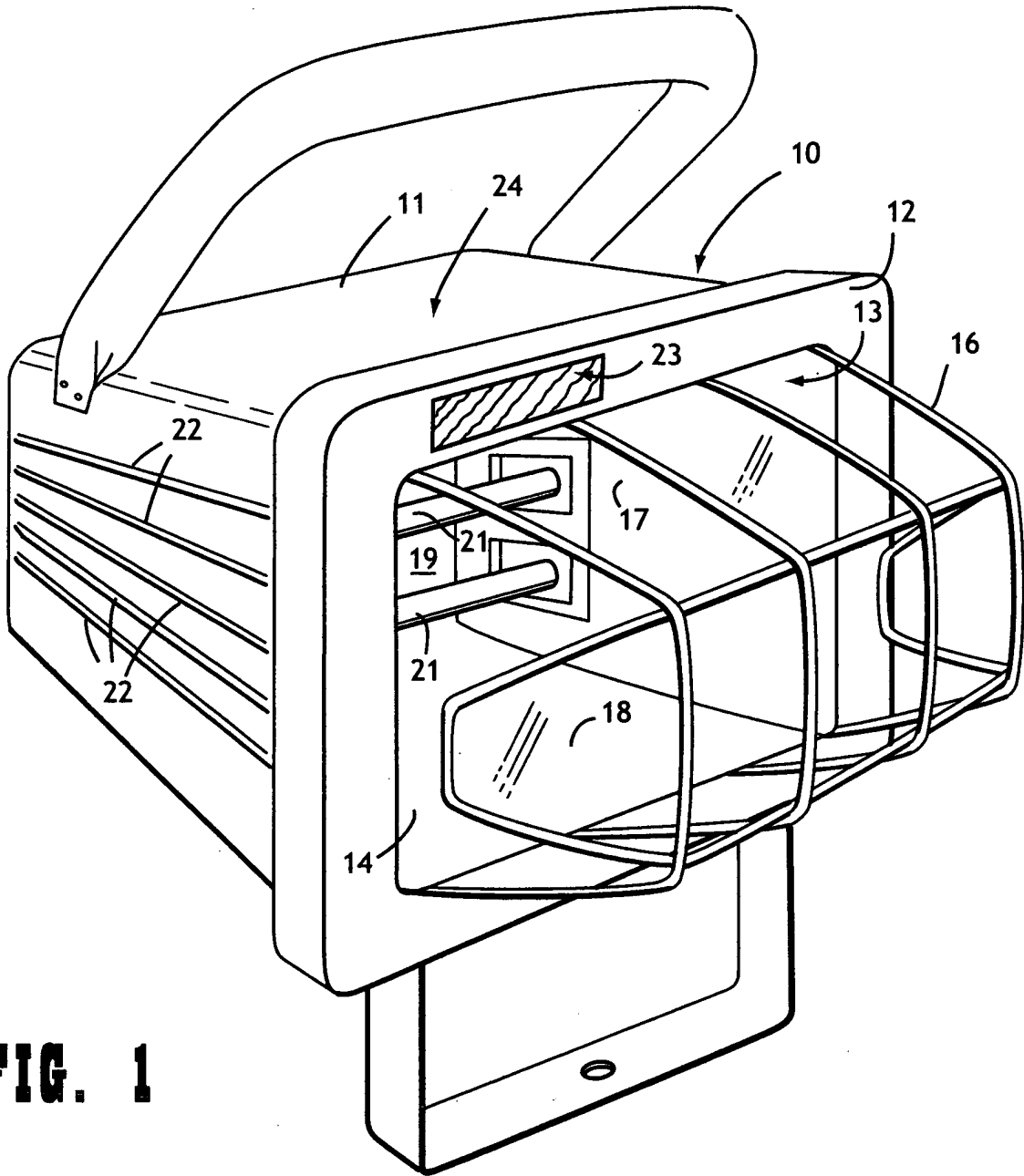

FIG. 1